



AS 75EI

fire doors system

The three-chamber AS 75EI system is intended for the production of thermally insulated doors with EI30 and EI60 fire resistance class for internal and external applications. Modern fireproof inserts provide fire resistance an simultaneously their design guarantees a simple and clean prefabrication.

EI 30

EI 60



BENEFITS OF AS 75EI SYSTEM:

- Fully compatible with product range, function and visuals of AS75 system.
- Single-side glazing as in typical door.
- Saint-Gobain - Vetrotech multivariate glazing.
- Door fittings of well-known brands: Wala, master, Dr Hahn, Wilka, MC Aluhard, Fuhr, Eco Schulte, Geze.
- Fast and efficient manufacturer certification.
- Adjustable system angles for glass fixing make it easier to assemble various glazing units.
- Improved prefabrication by adapting fireproof inserts to profile chamber shapes.
- Lightweight structure thanks to the use of perlite-based fireproof inserts.
- Thermally and mechanically (cracks and fractures) resistant, proprietary fireproof inserts.
- Clean and efficient production and storage, thanks to the plastic cover of the fireproof inserts.

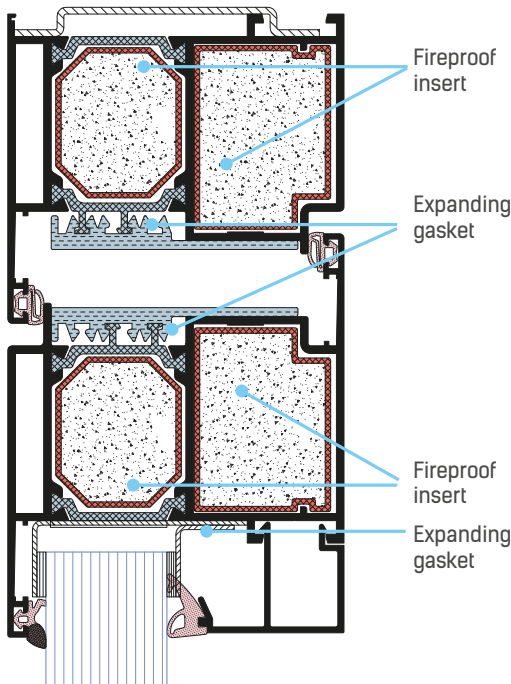

EI60 class door

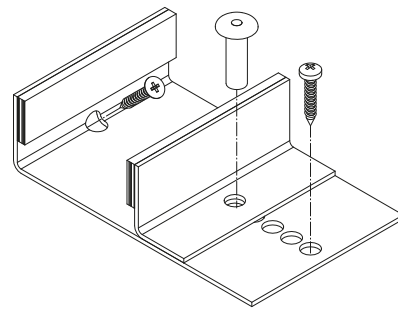

SELECTED FEATURES AND PARAMETERS OF THE SYSTEM

Door profile depth	75 mm	
Door glazing range	up to 56 mm	
Available hinge types	Surface hinges	
Smoke-proof doors	Sa, Sm class	
**Max sash height	2300 mm	
Glazing thickness in construction:	The range of singlelayer glazing	The range of possible combinations
*EI 30	15 i 16 mm	34-56 mm
*EI 60	27 mm	34-56mm

*The Possibility of creating a single or double-chamber glazing.

**Applies to single and double sash doors.

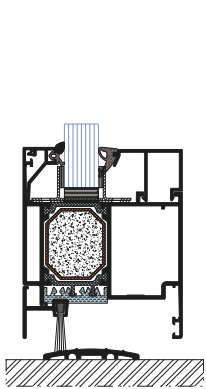
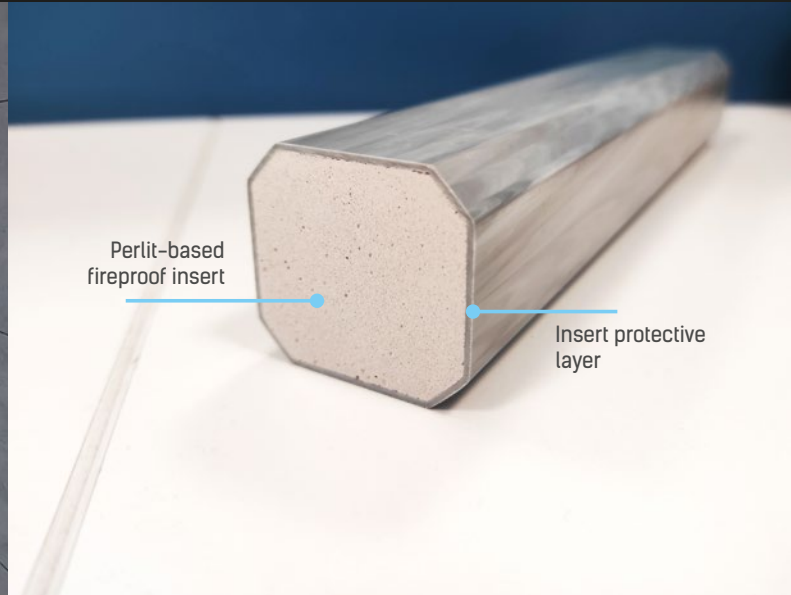

EI 30 bottom section with brush seal

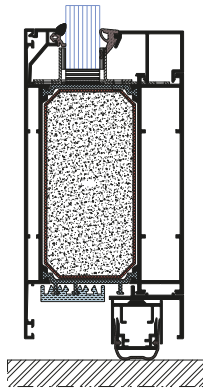

EI 30 bottom section with falling threshold

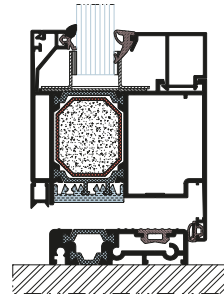

EI 30 bottom section with threshold

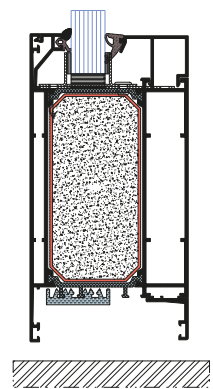

EI 30 bottom section with kick-plate

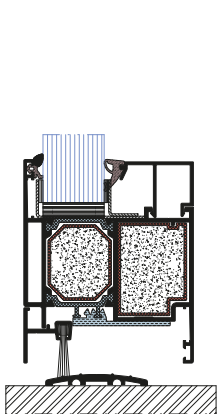

EI 60 bottom section with brush seal

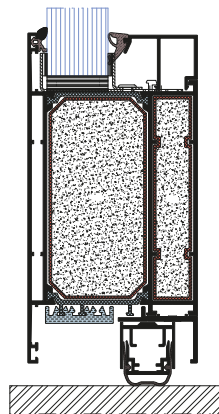

EI 60 bottom section with falling threshold

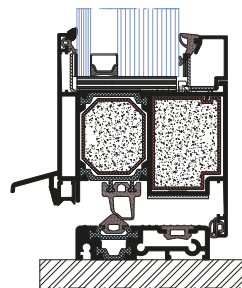

EI 30 bottom section with threshold

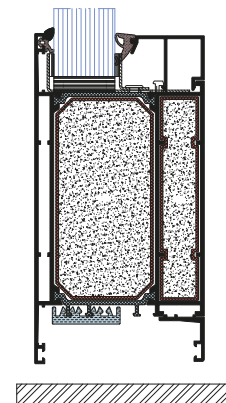

EI 60 bottom section with kick-plate

